

Specification Sheet

IY600 Industrial Washer



IY600

Capacity (Dry)	60 kg
Volume	600 L
Spin Type	High Spin
Door Opening	Ø 914 mm
Net Weight	1500 kg
Electrical Recommendations	80 Amp – 415 Volt – 3-phase Isolating Switch at 1.8m off floor
Water Recommendations (Hot)	1x Standard 25.4mm Washing Machine Tap
Water Recommendations (Cold)	2x Standard 25.4mm Washing Machine Tap
Water Pressure	Minimum = 44PSI (3 Bar), Maximum = 72PSI (5 Bar)
Drain	2x Ø 76mm outlets through floor
Foundations	Minimum 100mm M20 Grade Concrete Foundation

IY600

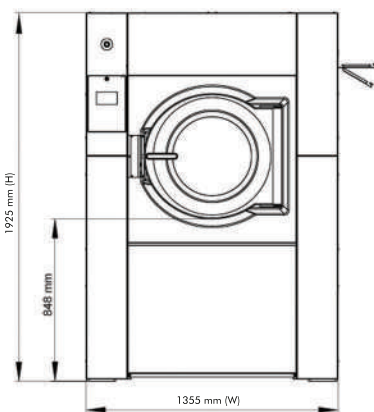

FRONT

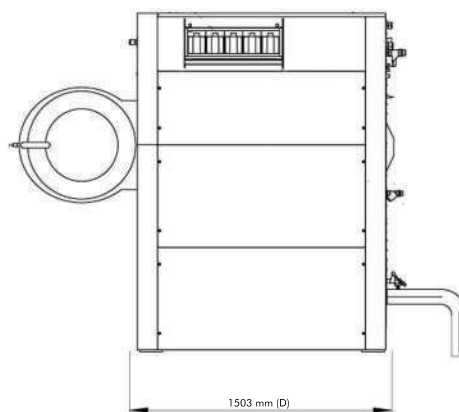

SIDE

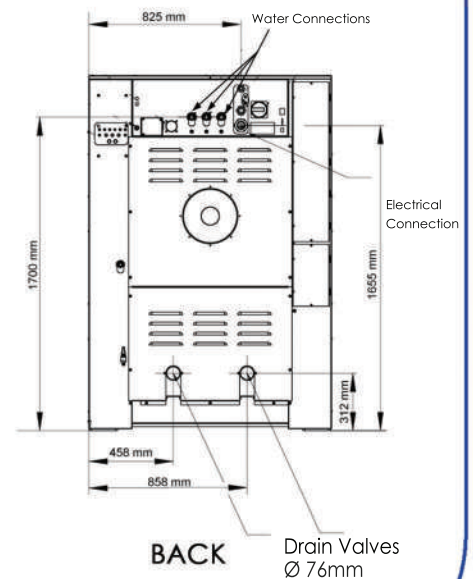

BACK