

Specification Sheet

IA180ES Industrial Washer



IA180ES

Capacity (Dry)	18 kg
Volume	180 L
Drum Type	Sluice Drum
Door Opening	Ø 460 mm
Net Weight	255 kg
Electrical Recommendations	32 Amp – 415 Volt – 3-phase Isolating Switch at 1.8m off floor
Water Recommendations (Hot)	1x Standard 19mm Washing Machine Tap
Water Recommendations (Cold)	2x Standard 19mm Washing Machine Tap
Water Pressure	Minimum = 44PSI (3 Bar), Maximum = 72PSI (5 Bar)
Drain	Ø 76mm through floor
Foundations	Minimum 100mm M20 Grade Concrete Foundation
Optional Plinth	395 mm (height) 6 mm (thickness) Ø 25 mm (bolt hole)

IA180ES

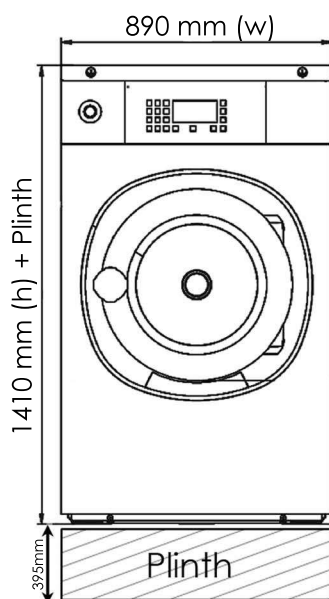

FRONT

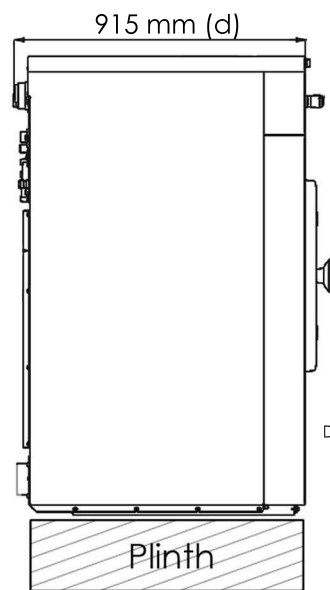

SIDE

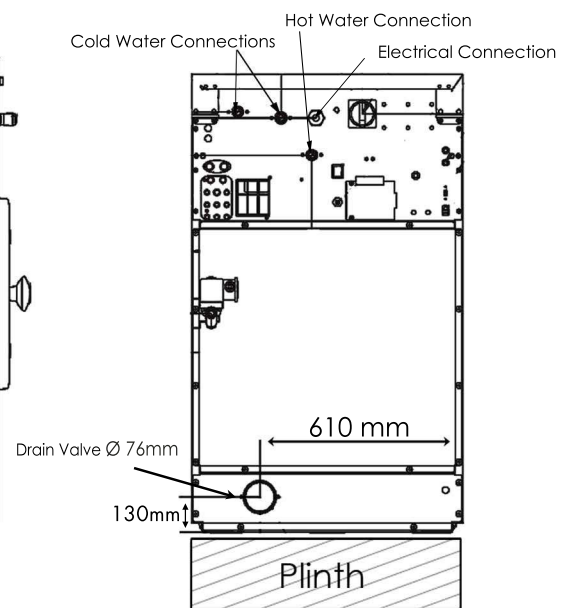

BACK